



ADJUSTABLE SPRING POWER - SURFACE APPLIED CLOSER

# 5000-TP SERIES



GRADE 1 • HANDICAP



5 YEAR WARRANTY  
[Click Here For Info.](#)



## FEATURES

- **Model 5001-TP**
- ADA (Handicap) multi-sized closer with adjustable spring power for a range of sizes. 1-6 adjustable back check and delay action, adjustable after installation.
- Two Speed Control Valves: Closing and latching speeds controlled by separate regulating valves, adjustable after installation.
- Universal application. Non-handed for standard, top jamb or parallel arm installation.
- Furnished with dress cover and PA bracket.
- Rack and pinion mechanism contained in a high tensile precision cast aluminum housing.
- Stable hydraulic door check fluid for any climatic operation and constant lubrication.
- Optional, hold-open arms.
- Hold-open arms are adjustable for holding from 90° to 180°

## FINISHES

- AL - Aluminum
- DU - Storefront Bronze



• Spring Power Adjustment

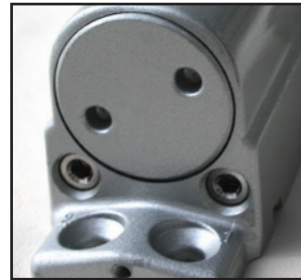

• Latching and Sweep Adjustment Valves

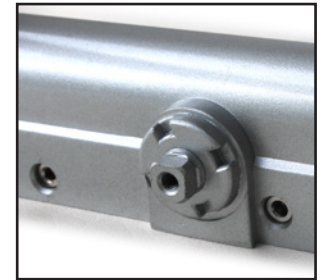

• Back-Check and Delay Adjustment Valve

## TECHNICAL DIMENSIONS

Description	WITH DRESS COVER	NO DRESS COVER
A. Length of Closer Body	13"	12 <sup>11</sup> / <sub>16</sub> "
B. Horizontal Mounting Holes	12"	12"
C. Vertical Mounting Holes	<sup>3</sup> / <sub>4</sub> "	<sup>3</sup> / <sub>4</sub> "
D. Overall Height	5 <sup>1</sup> / <sub>8</sub> "	5 <sup>1</sup> / <sub>16</sub> "
E. Top of Door to Bottom of Closer	3 <sup>1</sup> / <sub>2</sub> "	3 <sup>7</sup> / <sub>16</sub> "
F. Closer Body Height	3"	2 <sup>7</sup> / <sub>8</sub> "
G. Projection from Door	2 <sup>5</sup> / <sub>16</sub> "	2 <sup>3</sup> / <sub>16</sub> "

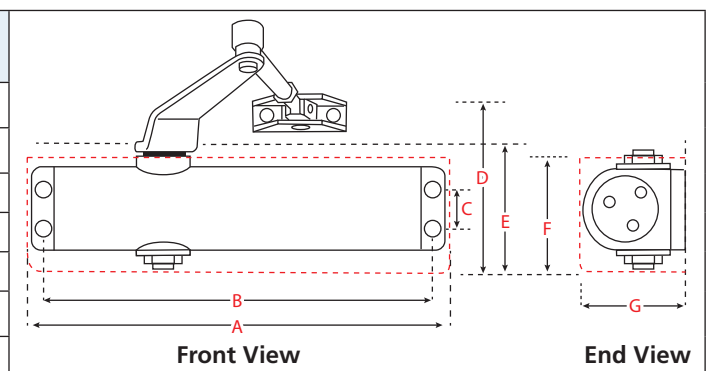

**International Door Closers, Inc.**

COPYRIGHT 2021 INTERNATIONAL DOOR CLOSERS, INC

**West: 800-544-4422 • East: 800-225-6737**

**www.intldoorclosers.com**

## INSTALLATION TYPES

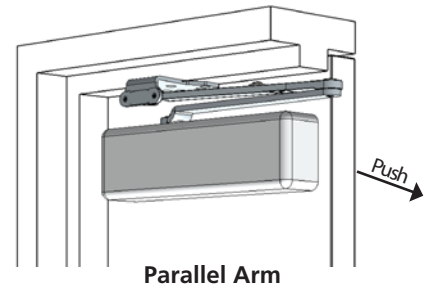
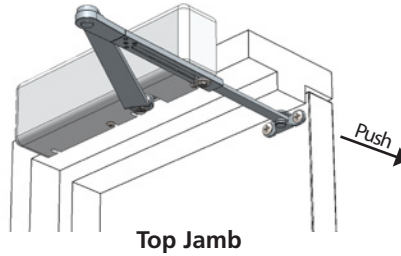
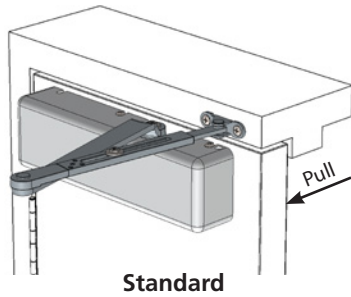







TYPICAL INSTALLATIONS (REGULAR ARMS SHOWN) Hold-Open Arms are similar

## SELECTION CHART

STYLE	MODEL NO.	TYPE
WITH DRESS COVER	5001-TP	Regular Arm Parallel Arm Hold-Open Arm Parallel Hold-Open Arm

## PARTS AND ACCESSORIES - 5001-TP

Parts	Description	Part #	<p><b>NOTE:</b> Doors of unusual height or weight, or doors subject to severe wind or draft conditions, or abusive usage, require one or two more full turns of hex spring adjustment nut than shown on the Installation instructions.</p> <p><b>SPECIFY:</b> Closer Model or Part Number</p> <p><b>SPECIFY FINISH:</b> AI-Aluminum DU -Storefront Bronze</p>
	Complete Arm Assembly	501	
	Hold-Open Forearm	522	
	Parallel Bracket for Regular Arm	525	
	Dress Cover	DC-5000	
	Thru Bolt & Grommet Nut (Set of 4 each)	TBGN-50	
	Sex Nuts & Bolts	18-SN	